

REACH STACKER



UP TO 99000 LBS. (50 TON) CAPACITY

SPECIFICATIONS



THD9900-R60-R68-R73-R77-R85-R90

CLASS
5

INTERNAL COMBUSTION ENGINE PNEUMATIC TIRE

ToyotaForklift.com

REACH STACKER

CAPACITY
UP TO 99000 LBS.

WHEELBASE
236 IN.

LOAD CENTER
78 IN.

INDUSTRIES



Intermodal/Port



Shipping Containers

STANDARD FEATURES

SUPPORT

- Electrical horn
- Asbestos-free components
- Neutral safety switch
- Integrated overhead guard
- Operator Restraint System (ORS) seat
- Operator Presence Sensing System (OPSS)

PERFORMANCE

- CUMMINS[®] 8.9-liter, 6-cylinder Tier 4 Final diesel engine
 - Common rail electronic fuel injection system
 - Turbocharged & intercooled
- Pivoting attachment with 4 ISO twistlocks
 - Extendable/retractable to 20' & 40' foot pick points
 - Automatic locking pendular floating twistlocks for handling 20' to 53' ISO containers
 - Large LED twistlock engagement indicator lights
 - Interlock safety system to ensure proper locking
 - 31.5" of side shift each way
 - Mechanical pile slope (+/- 5.0°)
- High-load composite side thrust bearings
- Boom-mounted twistlock indicator light
- Warning lights
 - battery charge
 - low engine oil pressure
 - low fuel level
 - water in fuel
 - high engine water temperature
 - clogging air filter
 - high transmission oil temperature
 - park & service brake
 - hydraulic filter
 - transmission filter
- Dana model 36000 transmission with 4 forward & 4 reverse speeds
- 4-spool main control valve (lift, tilt, extend, rotate)
- Charge air cooler with integral side by side radiator & transmission coolers
- Independent brake & brake/declutch pedals
- 2-stage high-strength steel telescoping boom
- Load-sensing, hydrostatic-powered steering
- Upswept exhaust
- 7" touch-screen multi-function display
 - Fuel gauge
 - Hour meter
 - Speedometer/Tachometer
 - Water temperature gauge
 - Engine oil pressure indicator
 - Parking brake indicator
 - DEF fluid indicators
 - Turn signal indicators
 - Estimated load weight indicator
 - Service and operator manuals
 - Pre-operation checklist (upon request)¹
 - Pin code entry system
 - Fuse/relay diagnostics

DURABILITY

- Force-cooled wet disc brakes
- Planetary drive axle rated for durability in high-capacity, off-road applications
- AxleTech[®] planetary drive axle rated for durability in high-capacity, off-road applications
- Heavy-duty, welded steer axle
- Rigidly constructed welded frame
- Engine protection system
- High-capacity cooling system
- Open core radiator with fan shroud motor & alternator
- Two industrial 8D 12V batteries
- Two-stage heavy-duty air cleaner
- 12-Volt electrical system with 12V starter motor & alternator
- "Brake Saver" system prevents travel when parking brake is applied

ERGONOMICS/CABIN

- LED front headlights (2)
- LED rear worklights (2)
- LED spreader lights (4)
- LED forward-facing fender-mounted worklights (2)
- LED rear-facing counterweight-mounted worklights (2)
- Stairway lighting
- Strobe light
- Forward & reverse travel alarms
- Single multifunction joystick control handle
- Key off headlights
- Sideview mirrors (right & left sides)
- Front indicator lights (2)
- Rear combination lights (2)
- Dashless cab design for improved visibility
- Front & rear windshield washer/wiper
- Top-mounted windshield wiper
- Cabin doors with sliding windows
- Individually controlled front/rear wipers
- LED twistlock indicator lights inside cab
- Tilt steering column
- Left-hand directional shift lever
- Onboard load weighing system
- Adjustable air-ride seat with retractable seatbelts and adjustable armrests
- Lockable doors with greaseable hinges
- Cab heater & defroster
- Tinted glass to minimize glare
- Four turn lock-to-lock steering wheel
- Emergency E-Stop in operator compartment
- Dome light
- Hydraulically powered traversing cab
- Rear window escape hatch

SERVICEABILITY

- Electronic engine diagnostics with fault code history
- Easy-access filters
- Hydraulic multi-gauge
- Externally serviceable brakes
- Bolt-on tanks, counterweights, cab super-structure & stairways (removable)
- External attachment spreader cylinders
- Powertrain access panels with quick-release latches

¹ Consult your local, authorized Toyota Dealer for customization options and pricing.

OPTIONAL EQUIPMENT

POWERTRAIN

- Precleaner
- Fitch fuel catalyst

LOAD HANDLING

- Hydraulic pile slope (requires 275" wheelbase)
- 4-point top pick ISO – twistlock
- WTP/pin module
- Trailer leg module
- Rear container guides
- Spreader beam slave attachments
- Twistlock snapshot camera system
- Container landing damage prevention system

COLD START AID

- Oil pan heater
- Engine block heater
- Hydraulic tank heater
- Battery pad warmer
- Coolant preheater

CAB/CONTROLS

- Open cab (less doors, glass, wipers, heat)
- AM/FM/CD with 2 speakers
- Auxiliary 12V power supply (pass through studs)
- Air-conditioning
- Top sunshade
- Single joystick control
- Orange seatbelt
- Rearview mirror (center mount)
- Auxiliary heater/front defrost
- 3-point seatbelt
- Floor-mounted computer stand

INDICATORS & MISC.

- Forward camera system visibility aid
- Rear camera system visibility aid
- Dual camera system visibility aid
- Onboard load weighing system (with tape printer)
- Fire extinguisher (5 lb. cab mount)
- Fire extinguisher (20 lb. chassis mount)
- Fire suppression system - Twin agent auto/manual
- Rear object detection radar
- 4-corner object detection radar
- Shock sensor warning system (w/logging)
- Tire pressure monitoring system
- 2nd position keyswitch twistlock override
- Ground-level E-Stop stations (1 each side)
- Ground-level monitoring kit w/ DVR
- French Canadian language

ELECTRICAL

- Jumpstart receptacle
- Lockable battery isolator

LIGHTS/ALARMS

- Extra strobe (magnetic)
- Forward travel alarm
- Various HID worklight upgrade options

SERVICE/MAINTENANCE

- Central lubrication system
- Auto-lubrication system (chassis)
- Auto-lubrication system (spreader)
- Engine oil purification system
- Onboard battery trickle charger
- Onboard stand-alone generator

PAINT OPTIONS (REQUIRES PAINT CODE & MAP)

- Custom color (single or dual)
- Chevron striping on counterweight
- Intermodal tire striping

WHEELS & TIRES

- Pneumatic
- Foam-filled pneumatic tires
- Foam-filled pneumatic tires (w/ opt. P052)
- Pneumatic tires (lugged)
- Pneumatic tires (smooth)
- Extra tire/rim

TRUCK SPECIFICATIONS

MODEL NUMBERS

GENERAL DATA			THD9900-R60	THD9900-R68	THD9900-R73
Load Capacity (First Row ¹)	lb (kg)		99000 (44900)	99000 (44900)	99000 (44900)
Load Capacity (Second Row)	lb (kg)		60000 (27200)	68000 (30850)	72600 (32900)
Load Capacity (Third Row)	lb (kg)		30000 (13600)	34000 (15420)	38500 (17460)
Load Center (Row 1 / Row 2 / Row 3) (P)	in (mm)		78 (1981) / 156 (3962) / 258 (6553)	78 (1981) / 156 (3962) / 258 (6553)	78 (1981) / 156 (3962) / 258 (6553)
Power Type			Diesel	Diesel	Diesel
Operator Position			Seated Rider	Seated Rider	Seated Rider
Tire Type	Front / Rear		Pneumatic	Pneumatic	Pneumatic
Wheels (x = driven)	Front / Rear		4x / 2	4x / 2	4x / 2
EXTERIOR DIMENSIONS			THD9900-R60	THD9900-R68	THD9900-R73
Boom Height (at maximum lift) (N)	in (mm)		736 (18694)	736 (18694)	736 (18694)
Boom Height (lowered) (A)	in (mm)		181 (4597)	181 (4597)	181 (4597)
Boom Angle (minimum / maximum)	deg		0 / 58.5	0 / 58.5	0 / 58.5
Lift Height (under twistlocks) (D)	in (mm)		606 (15392)	606 (15392)	606 (15392)
Lowered Height (under twistlocks) (B)	in (mm)		40 (1016)	40 (1016)	40 (1016)
Overall Length (with attachment) (C)	in (mm)		473 (12014)	473 (12014)	473 (12014)
Overall Length (without boom) (D)	in (mm)		314 (7976)	314 (7976)	314 (7976)
Spreader Width (20' / 40') (E)	in (mm)		273.5 (6033) / 479 (12167)	273.5 (6033) / 479 (12167)	273.5 (6033) / 479 (12167)
Pile Slope (mechanical / hydraulic) (+/-)	deg		5 / 4.5	5 / 4.5	5 / 4.5
Spreader Rotation (+/-)	deg		195 / 105	195 / 105	195 / 105
Sideshift (each way / total)	in (mm)		31.5 (800) / 63 (1600)	31.5 (800) / 63 (1600)	31.5 (800) / 63 (1600)
Overall Width (over drive tires) (F)	in (mm)		165 (4191)	165 (4191)	165 (4191)
Distance - Centerline of Front Axle to Face of Tires/Stabilizers (G)	in (mm)		32.25 (819)	32.25 (819)	32.25 (819)
Turning Radius (outside) (H)	in (mm)		343 (8712)	343 (8712)	343 (8712)
Basic Right-Angle Stacking Aisle Width (w/10% additional clearance)	in (mm)		480 (12192) / 565 (14351)	480 (12192) / 565 (14351)	480 (12192) / 565 (14351)
TIRES			THD9900-R60	THD9900-R68	THD9900-R73
Tires	Number (front / rear)		4 / 2	4 / 2	4 / 2
	Size (front / rear)		18.00-25 40PR / 18.00-25 40PR	18.00-25 40PR / 18.00-25 40PR	18.00-25 40PR / 18.00-25 40PR
Wheelbase (I)	in (mm)		236 (5994)	236 (5994)	236 (5994)
Tread Width (front) (J)	in (mm)		120 (3048)	120 (3048)	120 (3048)
Tread Width (rear) (K)			105 (2667)	105 (2667)	105 (2667)
Underclearance (full load)	Minimum with Load (L)	in (mm)	7.5 (190)	7.5 (190)	7.5 (190)
	Center of Wheelbase (M)	in (mm)	16 (406)	16 (406)	16 (406)
Brake	Service (foot) / Parking		Wet disc / Caliper	Wet disc / Caliper	Wet disc / Caliper
POWER SYSTEM			THD9900-R60	THD9900-R68	THD9900-R73
Battery (5-hour rating)	V / Ah		12 / 1300	12 / 1300	12 / 1300
Internal Combustion Engine	Make / Model		CUMMINS 8.9L QSL9	CUMMINS 8.9L QSL9	CUMMINS 8.9L QSL9
	Rated Horsepower @ rpm	SAE HP	380 @ 2100	380 @ 2100	380 @ 2100
		(kW)	(283 @ 2100)	(283 @ 2100)	(283 @ 2100)
	Rated Torque @ rpm	SAE ft-lb	1201 @ 1500	1201 @ 1500	1201 @ 1500
		(N-m)	(1628 @ 1500)	(1628 @ 1500)	(1628 @ 1500)
	Number of Cylinders		6	6	6
Piston Displacement	cu in (cc)	660 (10815)	660 (10815)	660 (10815)	
Fuel Tank Capacity	US gal (liter)	155 (587)	155 (587)	155 (587)	
Transmission	Type		POWERSHIFT - AUTOSHIFT	POWERSHIFT - AUTOSHIFT	POWERSHIFT - AUTOSHIFT
	Speeds (forward / reverse)		4 / 4	4 / 4	4 / 4
Auxiliary Hydraulic Function Specifications (for attachments)	Max. Operating Pressure	psi (kg/cm ²)	2400 (168.7)	2400 (168.7)	2400 (168.7)
	Max. Flow Rate	gpm (lpm)	25 (94.6)	25 (94.6)	25 (94.6)

¹ Rated capacity is for stacking up to 4 high in the first row. Please see the capacity rating diagrams on page 7 for more information.

TRUCK SPECIFICATIONS

MODEL NUMBERS

GENERAL DATA			THD9900-R77	THD9900-R85	THD9900-R90
Load Capacity (First Row ¹)	lb (kg)		99000 (44900)	99000 (44900)	99000 (44900)
Load Capacity (Second Row)	lb (kg)		77000 (34900)	85000 (38600)	90000 (40000)
Load Capacity (Third Row)	lb (kg)		44000 (20000)	47000 (21300)	68000 (30800)
Load Center (Row 1 / Row 2 / Row 3) (P)	in (mm)		78 (1981) / 156 (3962) / 258 (6553)	78 (1981) / 156 (3962) / 258 (6553)	78 (1981) / 156 (3962) / 258 (6553)
Power Type			Diesel	Diesel	Diesel
Operator Position			Seated Rider	Seated Rider	Seated Rider
Tire Type	Front / Rear		Pneumatic	Pneumatic	Pneumatic
Wheels (x = driven)	Front / Rear		4x / 2	4x / 2	4x / 2
EXTERIOR DIMENSIONS			THD9900-R77	THD9900-R85	THD9900-R90
Boom Height (at maximum lift) (N)	in (mm)		736 (18694)	738 (18745)	738 (18745)
Boom Height (lowered) (A)	in (mm)		181 (4597)	183 (4648)	183 (4648)
Boom Angle (minimum / maximum)	deg		0 / 58.5	0 / 58.5	0 / 58.5
Lift Height (under twistlocks) (D)	in (mm)		606 (15392)	608 (15443)	608 (15443)
Lowered Height (under twistlocks) (B)	in (mm)		40 (1016)	42 (1067)	42 (1067)
Overall Length (with attachment) (C)	in (mm)		473 (12014)	512 (13005)	512 (13005)
Overall Length (without boom) (D)	in (mm)		314 (7976)	356 (9042)	361 (9169)
Spreader Width (20' / 40') (E)	in (mm)		273.5 (6033) / 479 (12167)	273.5 (6033) / 479 (12167)	273.5 (6033) / 479 (12167)
Pile Slope (mechanical / hydraulic) (+/-)	deg		5 / 4.5	5 / 4.5	5 / 4.5
Spreader Rotation (+/-)	deg		195 / 105	195 / 105	195 / 105
Sideshift (each way / total)	in (mm)		31.5 (800) / 63 (1600)	31.5 (800) / 63 (1600)	31.5 (800) / 63 (1600)
Overall Width (over drive tires) (F)	in (mm)		165 (4191)	172 (4369)	172 (4369)
Distance - Centerline of Front Axle to Face of Tires/Stabilizers (G)	in (mm)		32.25 (819)	35 (889)	35 (889)
Turning Radius (outside) (H)	in (mm)		343 (8712)	381 (9677)	381 (9677)
Basic Right-Angle Stacking Aisle Width (w/10% additional clearance)	in (mm)		480 (12192) / 565 (14351)	508 (12903) / 586 (14884)	508 (12903) / 586 (14884)
TIRES			THD9900-R77	THD9900-R85	THD9900-R90
Tires	Number (front / rear)		4 / 2	4 / 2	4 / 2
	Size (front / rear)		18.00-25 40PR / 18.00-25 40PR	21.00-25 40PR / 18.00-25 40PR	21.00-25 40PR / 18.00-25 40PR
Wheelbase (I)	in (mm)		236 (5994)	275 (6985)	275 (6985)
Tread Width (front) (J)	in (mm)		120 (3048)	120 (3048)	120 (3048)
Tread Width (rear) (K)	in (mm)		105 (2667)	105 (2667)	105 (2667)
Underclearance (full load)	Minimum with Load (L)	in (mm)	7.5 (190)	9.5 (241)	9.5 (241)
	Center of Wheelbase (M)	in (mm)	16 (406)	18 (457)	18 (457)
Brake	Service (foot) / Parking		Wet disc / Caliper	Wet disc / Caliper	Wet disc / Caliper
POWER SYSTEM			THD9900-R77	THD9900-R85	THD9900-R90
Battery (5-hour rating)	V / Ah		12 / 1300	12 / 1300	12 / 1300
Internal Combustion Engine	Make / Model		CUMMINS 8.9L QSL9	CUMMINS 8.9L QSL9	CUMMINS 8.9L QSL9
	Rated Horsepower @ rpm	SAE HP	380 @ 2100	380 @ 2100	380 @ 2100
		(kW)	(283 @ 2100)	(283 @ 2100)	(283 @ 2100)
	Rated Torque @ rpm	SAE ft-lb	1201 @ 1500	1201 @ 1500	1201 @ 1500
		(N-m)	(1628 @ 1500)	(1628 @ 1500)	(1628 @ 1500)
	Number of Cylinders		6	6	6
Piston Displacement	cu in (cc)	660 (10815)	660 (10815)	660 (10815)	
Fuel Tank Capacity	US gal (liter)	155 (587)	155 (587)	155 (587)	
Transmission	Type		POWERSHIFT - AUTOSHIFT	POWERSHIFT - AUTOSHIFT	POWERSHIFT - AUTOSHIFT
	Speeds (forward / reverse)		4 / 4	4 / 4	4 / 4
Auxiliary Hydraulic Function Specifications (for attachments)	Max. Operating Pressure	psi (kg/cm ²)	2400 (168.7)	2400 (168.7)	2400 (168.7)
	Max. Flow Rate	gpm (lpm)	25 (94.6)	25 (94.6)	25 (94.6)

¹ Rated capacity is for stacking up to 4 high in the first row. Please see the capacity rating diagrams on page 7 for more information.

EXTERIOR DIMENSIONS

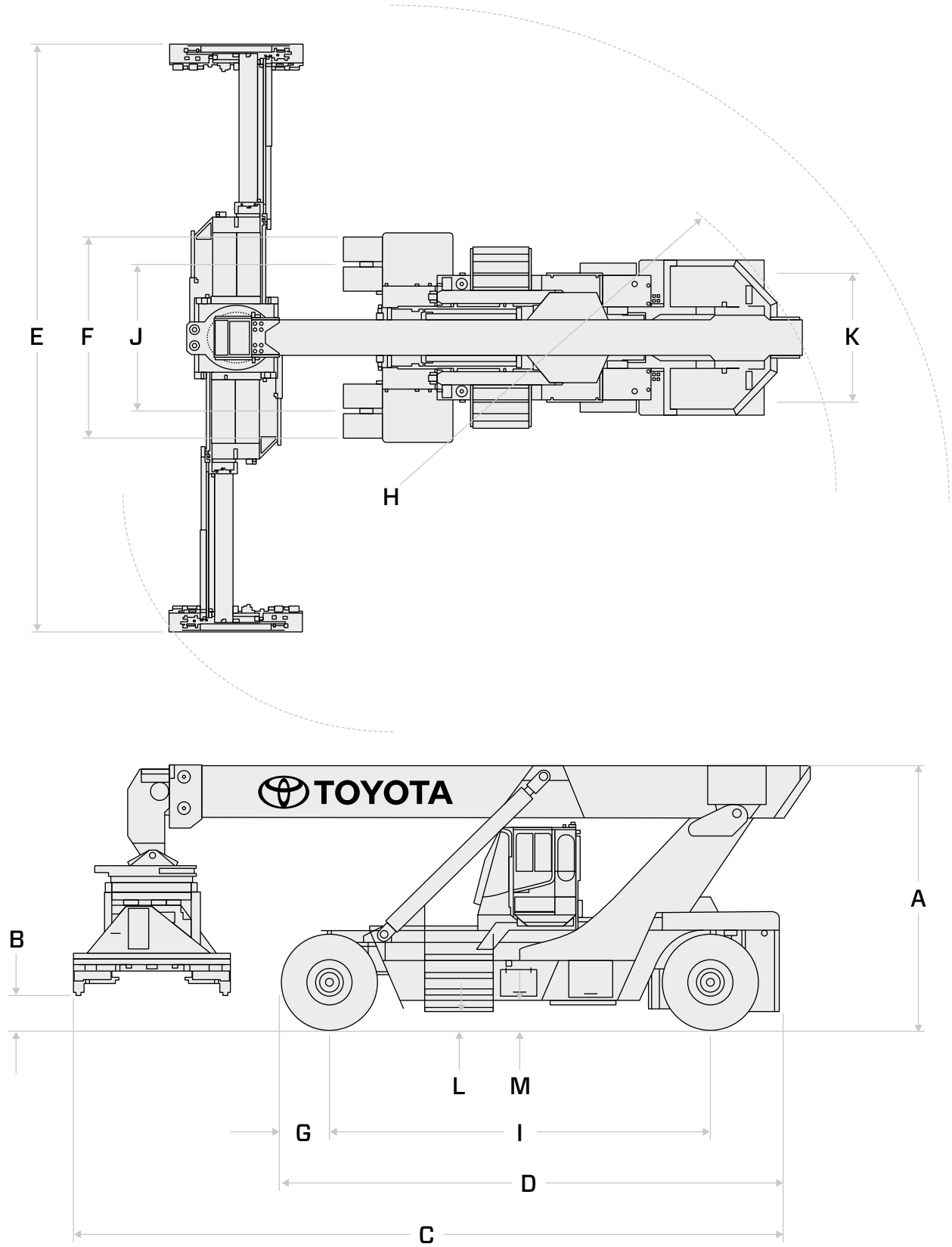

STACKING CAPACITIES

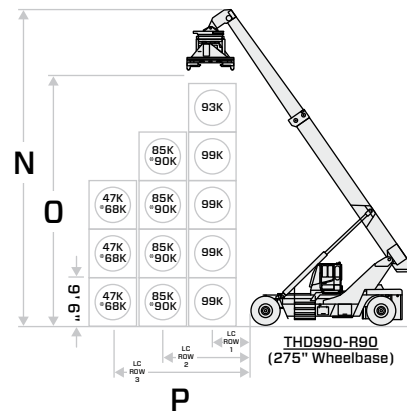
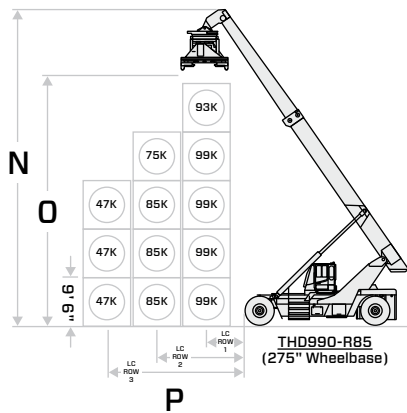
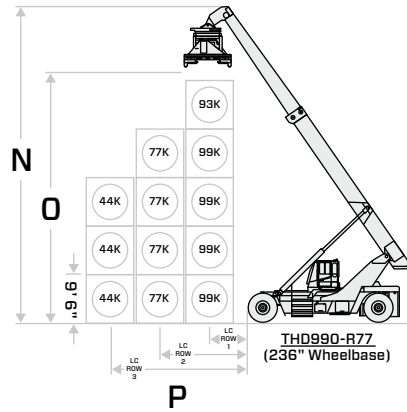
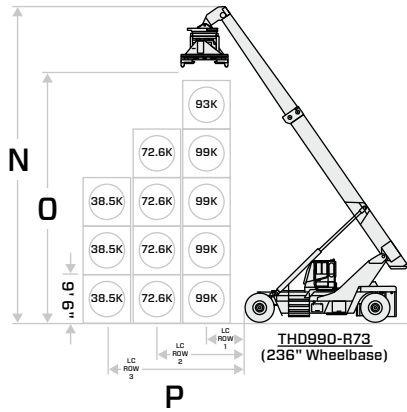
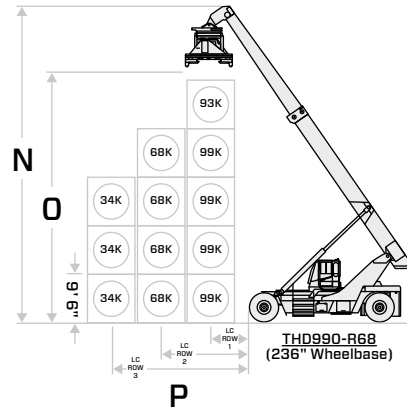
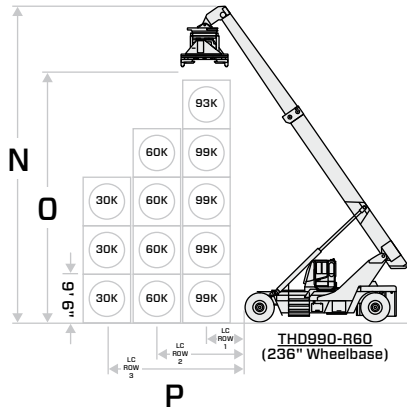

*Capacity to second rail with stabilizers down.

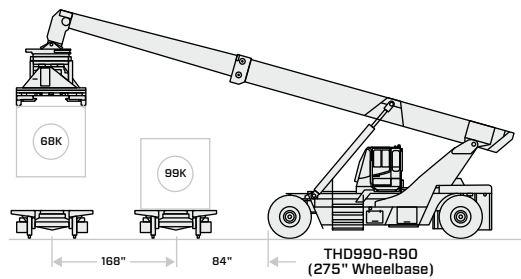

Some product features described herein are optional. Please consult your dealer for specifications.
Details of specifications and equipment are based on information available at time of printing and may change without notice.

